

USE AND MAINTENANCE MANUAL

SIMPOOL AUTOMATIC



INDEX

1. INTRODUCTION.....	3
1.1 WARNINGS.....	3
1.2 NORMATIVE REFERENCES	3
1.3 MODELS	4
1.4 INSTALLATION KIT	4
2. ASSEMBLY	4
2.1 WALL MOUNTING	4
2.2 ASSEMBLY OF ACCESSORIES AND OPTIONALS	4
3. FEATURES	5
3.1 ELECTRICAL FEATURES	5
3.2 USER INTERFACE.....	5
3.3 WORKING MODE.....	5
3.4 OTHER FEATURES	6
3.5 CIRCUIT BOARD LAYOUT.....	6
3.6 CONNECTOR BOX	7
4. HYDRAULIC CONNECTION	8
5. USER MENU.....	9
5.1 INITIAL MENU'	9
5.1.1 STATES AND ALARMS SHOWN.....	9
5.1.2 OPERATING INFORMATION.....	10
5.1.3 SIGNALS OF THE TWO-COLORED LED.....	11
5.2 PROGRAMMING MENU.....	12
5.2.1 PROGRAMMING EXAMPLE	13
5.2.2 CALIBRATION PUMP.....	14
5.2.3 FUNCTIONING HOURS	14
5.2.4 INHIBIT SIGNAL THRESHOLD ADJUSTMENT	14
5.2.5 DEFAULT PARAMETERS.....	15
6. MAINTENANCE	15
6.1 GENERAL RULES	15
6.2 PERIODIC MAINTENANCE	15
6.3 PLACING BACK PERISTALTIC TUBE.....	16
APPENDICE A – DIMENSIONI / APPENDIX A - DIMENSIONS	17

1. INTRODUCTION

The Simpool Automatic pump is a digital peristaltic dosing pump designed for the automatic management of the dosage of swimming pools.

Based on some simple parameters to be set, the pump is able to calculate by itself the dosage to be carried out and set the operating parameters to guarantee this daily dosage.

The parameters to be set are very simple and are: pool water volume, concentration of the product to be dosed and daily hours of operation.

It is also possible to connect the pump to a flow sensor and / or to the swimming pool recirculation pump, to make sure that the dosage takes place only when necessary.

1.1 WARNINGS



Before starting assembly, carefully read these instructions and follow them during installation.



If the instructions in this manual are not followed or carried out correctly, this may result in personal injury or damage the device and/or systems.

We recommend reading the label on the pump and checking the directions below:

- ✓ ***The pressure of the injection point must be lower or equal to the pump's rated value!***
- ✓ ***When you receive the product, check the integrity of the pump and all of its parts. Should there be any anomalies, promptly notify the seller before performing any operations.***
- ✓ ***Keep this manual safe for future reference.***
- ✓ ***Before installing the pump make sure that the details provided on the adhesive plate attached to the pump correspond to those of the electrical system.***
- ✓ ***Do not handle the equipment with wet hands or feet!***
- ✓ ***Do not leave the equipment exposed to the elements!***
- ✓ ***Make sure the peristaltic tube is compatible with the liquid to be dosed!***
- ✓ ***The equipment must be handled by qualified personnel!***
- ✓ ***If any irregularities are experienced during pump operation, cut off the power supply and contact one of our customer care centres for any repairs!***
- ✓ ***In order for the pump to operate correctly it is necessary to use original spare parts or accessories. The manufacturer is relieved of any responsibility in the case of any breakdowns due to tampering or use of non-conforming parts and accessories***
- ✓ ***The electrical system must comply with regulations in force in the country where the system is installed.***
- ✓ ***The operating ambient temperature must not exceed 40°C with a relative humidity of 90% at 90°C.***

1.2 NORMATIVE REFERENCES

Our pumps are manufactured according to General Standards in force and in compliance with the following European Directives:

n° 2014/30/CE " E.M.C.

n° 2014/35/CE "DBT Low Voltage Directive"

n° 2011/65/UE , 2012/19/UE "direttive RoHs e WEEE"

1.3 MODELS

Code	Power Supply	Motor Type	Flow rate (l/h)	Pressure (bar)	Peristaltic tube
ADS3002010000000	230 VAC	24 VDC	1,4	1	Santoprene
ADS3001010000000	230 VAC	24 VDC	3	1	Santoprene
ADS3003010000000	230 VAC	24 VDC	6	1	Santoprene

1.4 INSTALLATION KIT

At the time of purchase of the pump, everything necessary for a correct installation is included with it, in particular:

- Fixing bracket;
- Dowels and fixing screws;
- Bottom filter;
- Injection valve;
- Suction and delivery pipes;
- Use and maintenance manual.

2. ASSEMBLY



We always recommend wearing protective masks, gloves, goggles and any other PPE during all installation steps and when handling chemical products.

2.1 WALL MOUNTING

Proceed as follows to secure the pump to the wall:

- Fix the bracket to the wall using the plugs and screws supplied.
- Place the pump on the bracket.
- Ensure the fixing is stable.



It is also recommended to install the pump in a dry environment, away from heat sources and exhaust vapour.

2.2 ASSEMBLY OF ACCESSORIES AND OPTIONALS

- The injection valve must be inserted along the pool's recirculating water pipe. A special seat must therefore be created with a stub or with special collar accessories (excluded from the supply).
- Check the direction of flow in the tube to correctly insert the injection tube.
- If you install a flow sensor (OPTIONAL), the flow sensor + collar kit can be used as shown in the image on the side, having the following codes:
 - 700800122 - collar DN50
 - 700800123 - collar DN63



3. FEATURES

3.1 ELECTRICAL FEATURES

Power supply: 230VAC 50/60Hz

Fuse: 1 A RIT – model 5x20

3.2 USER INTERFACE

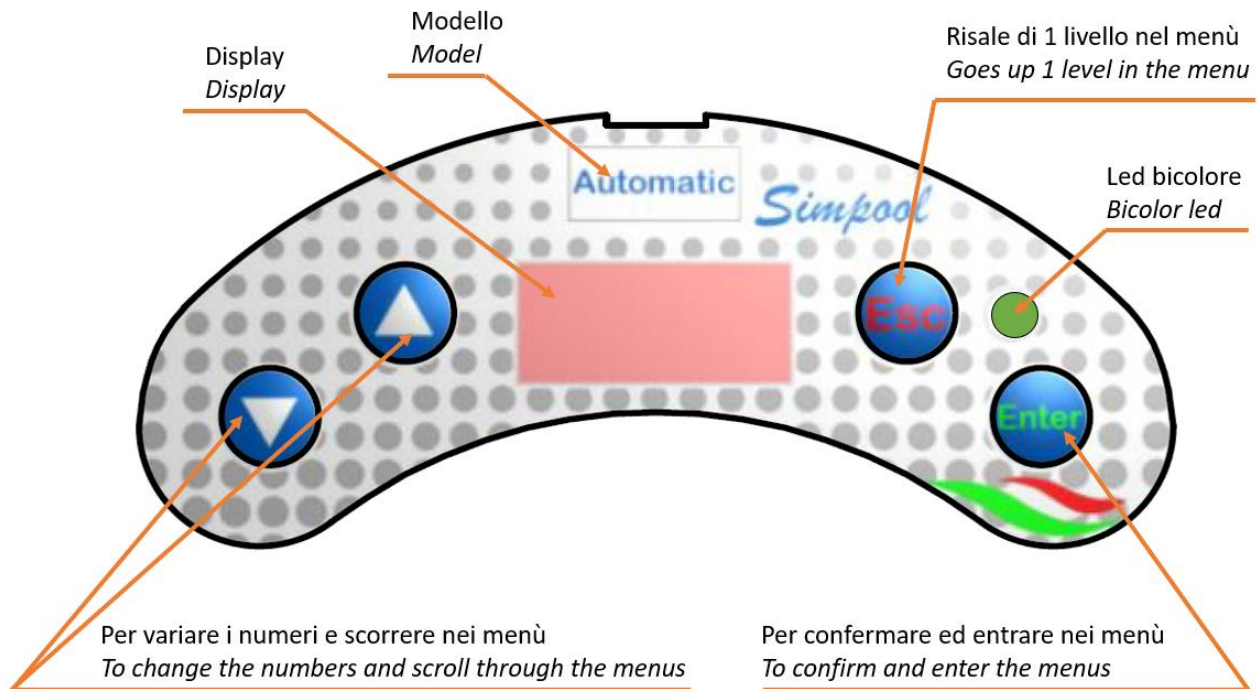

The keys on the panel are as follows:

- **Up / Down:** they allow Increment / Decrement, allowing you to change the numeric values and scroll through the lists of options for all the editable menu items.
- **Esc:** allows you to go up one level within the menus.
- **Enter:** allows you to enter a specific menu item and confirm.

3.3 WORKING MODE

The pump has the following functional characteristics:

- **Continuous dosing**

Dosing takes place continuously during the set daily operating hours. The pump adjusts itself to ensure the necessary dosage, depending on the volume of the pool water, the concentration of the liquid to be dosed and the daily operating hours of the dosing pump. Once the daily operating hours have been set, the pump starts and shuts off according to the inhibit connection with the pool filtration pump and / or the flow sensor possibly installed on the pool water delivery.

- **Time-Pause dosage.**

The dosage takes place in time-pause mode when too small a dosage is required for the pump to guarantee it with the "continuous dosing" mode. In this condition, the pump sets to the minimum possible operating speed (10%), after which, to guarantee the required dosage, it goes into time-pause mode. In other words, it carries out dosing breaks followed by dosing at the minimum speed. In this way, a homogeneous distribution of the product to be dosed during the set operating hours is guaranteed.

- **Priming function**



Pressing and releasing the button in position II starts the priming of the pump, which lasts 60 seconds. Pressing and releasing the button again before the 60 seconds have elapsed stops priming.

- **Calibration**

From the PROGRAMMING MENU it is possible to access the calibration function that allows you to assign the right maximum flow rate value to the pump, in the actual installation condition. On the basis of this value, the pump automatically calculates the reduction necessary according to the set values.

3.4 OTHER FEATURES

- **Level alarm**

It is activated when the product to be dosed runs out. The level alarm activates the acoustic signal buzzer.

- **Underdose alarm**

It is activated when, from the programming of the data entered, the pump detects that it is asked for a continuous dosage lower than that which can keep the motor at minimum speed. In this case, the pump automatically calculates a discontinuous dosage stop / go mode and, via the underdosing alarm, signals that it has set itself in this time / pause mode.

- **Overdose alarm**

It is activated when, from the programming of the entered data, the pump detects that it is asked for a dosage higher than its possibilities. In this case, the pump goes to the maximum dosage conditions, and simultaneously signals with the overdose alarm that it cannot guarantee the required dosage.

- **Engine alarm**

It is activated if for some reason the engine stops and fails to restart within 3 automatic attempts to restart.

- **Signaling absence or waiting for signals**

When there is no inhibit signal or flow signal or when, despite the presence of one or both of these signals, a stabilization of the signal itself is awaited.

For example, when the operating mode is activated which foresees the simultaneous presence of Inhibit and the presence of Flow and one of these two signals is not active.

3.5 CIRCUIT BOARD LAYOUT

The electronic board is equipped with a series of connectors, for the connection of the following signals or power supplies:

Rif.	Description
1	Equipment Power Supply Connector
2	Inhibiting signal connector
3	Motor connector
4	BNC Level Connector
5	Switch Connector
6	Flux sensor
7	Buzzer

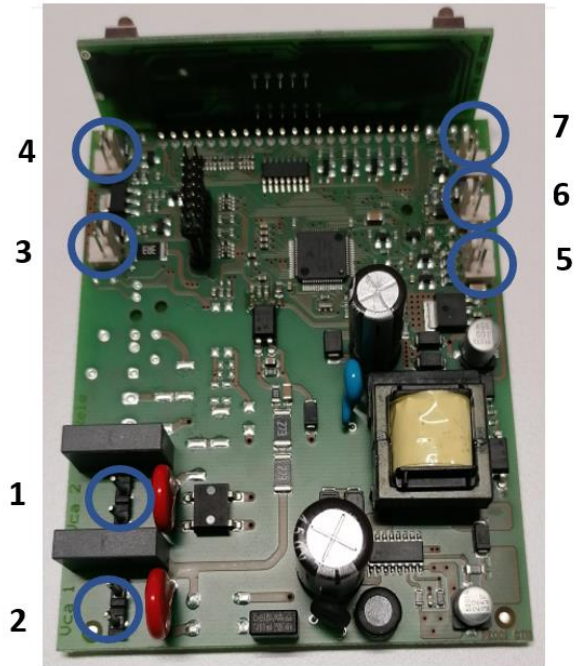
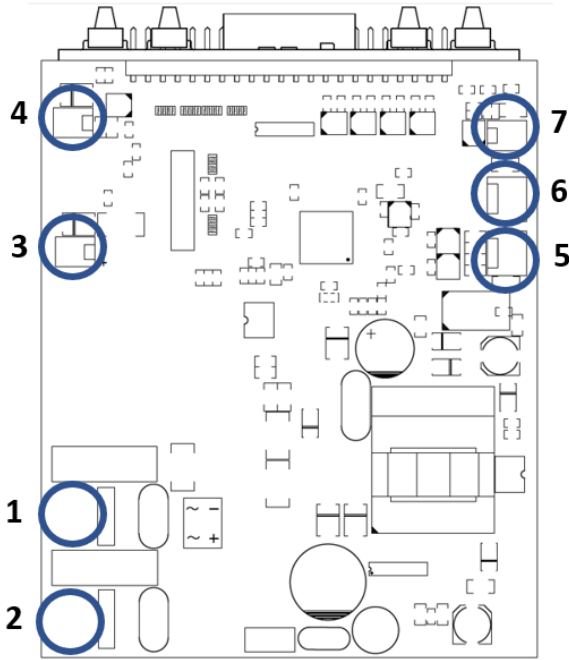

3.6 CONNECTOR BOX



Before performing any maintenance on the pump, disconnect the power supply voltage of the machine!

The casing has, on its lower part, the following electrical connections:

- Three-position switch for the following functions:

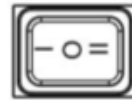

- I : the pump is active (ON);
- O : the pump is off (OFF);
- II : To activate priming (MOM)

The MOM position is monostable, so after having positioned the switch in MOM, when released, the switch will automatically reposition itself in OFF. The pump doses for 60 seconds at maximum speed and then goes to the OFF position.

If you press the MOM button while priming is in progress (before the preset 60 seconds), priming is stopped and the pump is set to OFF.

- 230 Vac / 50Hz power supply cable
- BNC connector for level probe;
- BNC connector for ON-OFF flow sensor;
- Cable for inhibit connection to the swimming pool filtration pump (or other appliance capable of conditioning the start / stop of the pump).

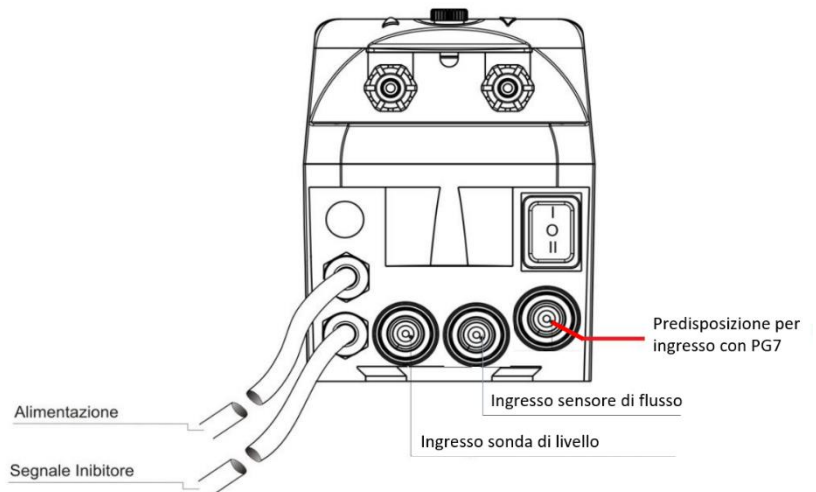

4. HYDRAULIC CONNECTION

- Insert the bottom filter, or in any case the end of the suction tube, into the tank of the product to be dosed;
- Connect the suction pipe to the pump suction fitting (marked on the cover with ▲) and tighten the appropriate ring nut.
- Connect the delivery pipe to the pump delivery fitting (marked on the cover with ▼) and tighten the appropriate ring nut;
- Connect the delivery pipe to the injection valve or, in any case, to the system designed for injection and connect everything to the pipe where the product must be dosed;
- The link looks like the image below:

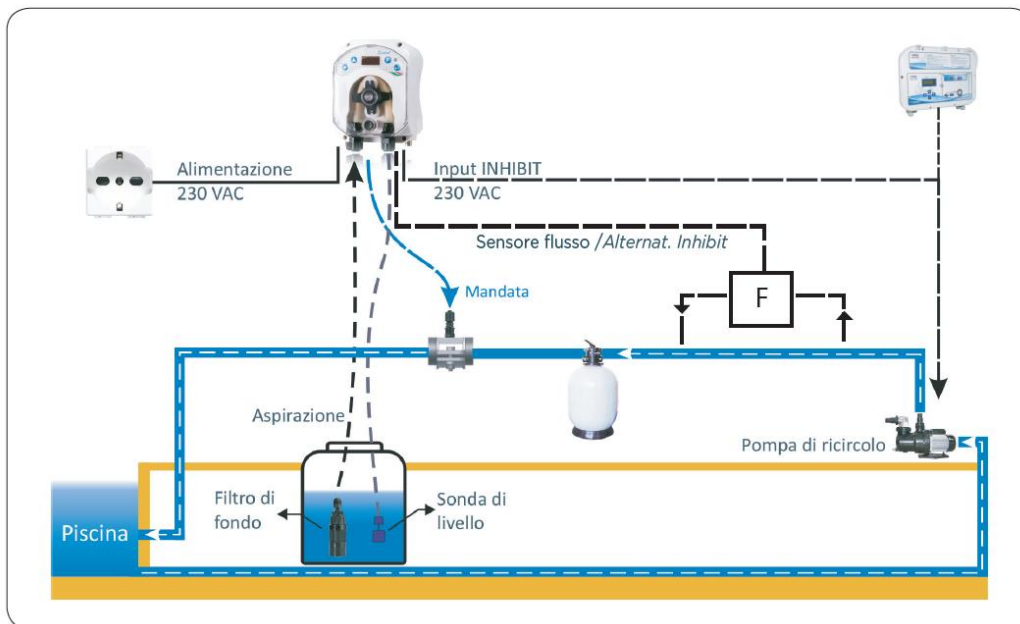

5. USER MENU

5.1 INITIAL MENU'

5.1.1 STATES AND ALARMS SHOWN

During operation, the display indicates the operating status of the pump. The following reports may appear:

**DOSING**

Indicates that the pump is performing the set dosage.

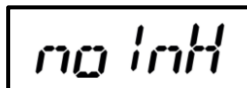
**noINHIBIT**

Indicates that the pump is waiting for the inhibit signal from the circulation pump. In this state the pump is not dosing.

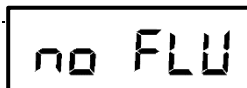
**noFLUX**

Indicates that the pump is waiting for the flow sensor signal. In this state the pump is not dosing.

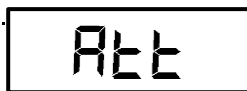
**WAITING**

Indicates that the pump is in a state of standby for flow stabilization or inhibit signal. If the program is ALL, with Att the pum signal that it attend une or two signal for start. In this state the pump is not dosing.

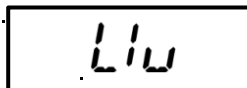
**LEVEL ALARM**

Indicates that the product exhaustion level alarm has been activated. The pump stops pending the recovery of liquid to be dosed.

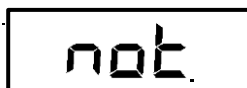
**MOTOR ALARM**

Indicates that the pump has a blocked motor. Although the pump has attempted 3 times to restart the engine, it has failed. The pump does not dose.

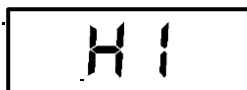
**OVERDOSING ALARM**

Indicates that the pump is unable to dose the quantity of product required. In this mode the pump doses at its maximum potential, which however is not sufficient to satisfy the request.

**UNDERDOSING ALARM**

It indicates that the pump is not able to continuously dose the quantity of product that is requested because it is too low. In this mode, the pump is positioned at minimum engine speed and activates an automatic pause-time mode to try to get as close as possible to the required dosage.

5.1.2 OPERATING INFORMATION

During the DOSING operating state it is possible to view the pump setting parameters using the UP and DOWN scroll keys. Scrolling the menu starting from the DOSAGE state you will find the following menu instructions:

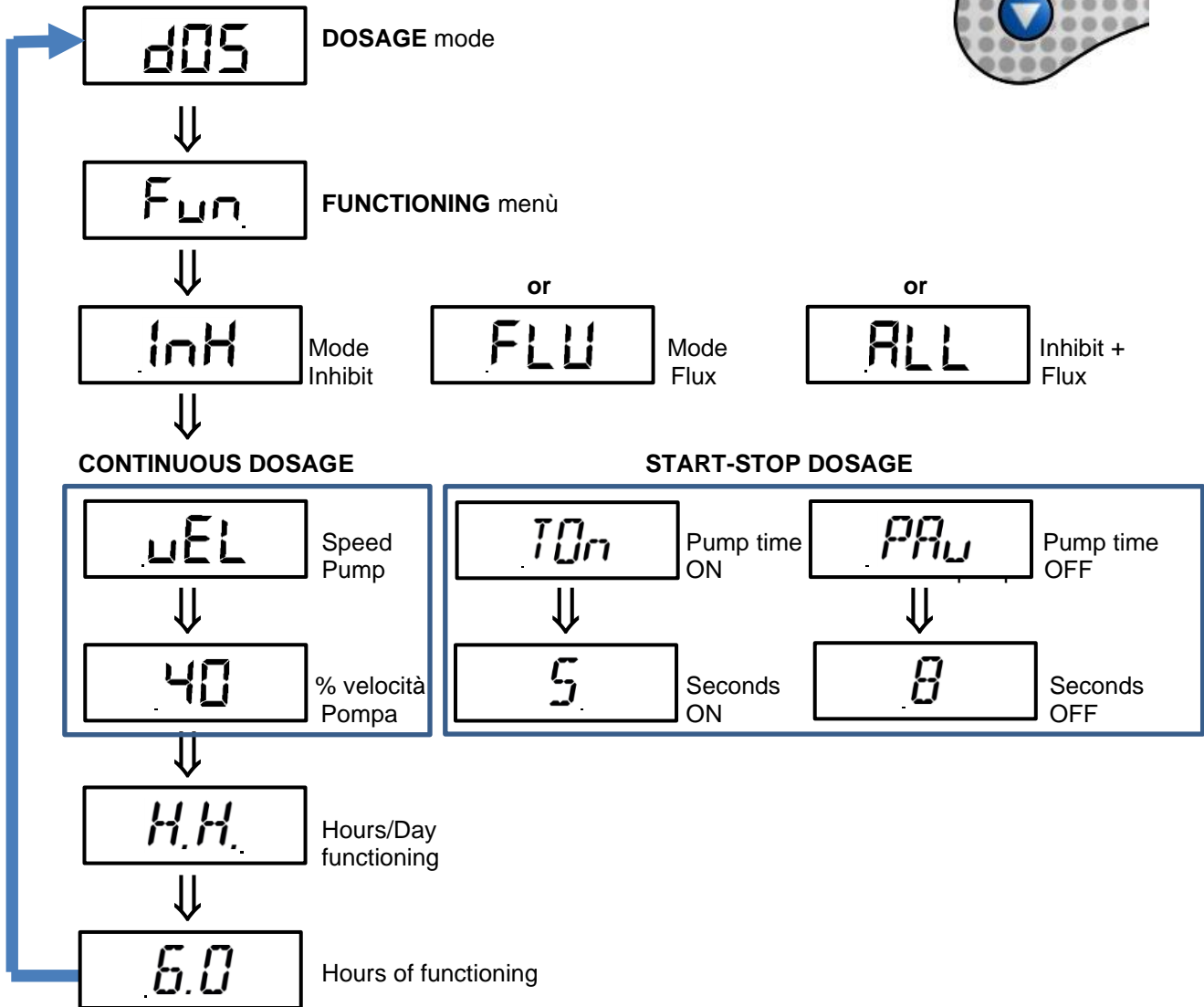
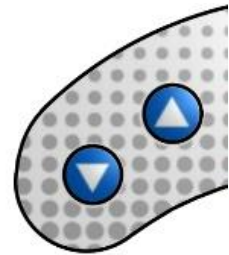

In practice, scrolling with the UP-DOWN keys you pass in sequence all the pump operating information, namely:

- The type of activation setting: through inhibit connection to the dosing pump (InH), or through connection to flow sensor (FLU), or through the combination of both solutions (ALL) which corresponds to the fact that these signals both must be active.
- In continuous mode: the percentage of partialisation with respect to the maximum nominal flow of the pump. During operation at maximum speed, the display will indicate the value 100. For reduced flow operations, the display shows the actual operating speed, less than 100%. This value cannot go down to less than 10%. If a dosage lower than 10% of the nominal flow is required, the pause-time mode is activated. If a dosage higher than 10% is required, in addition to activating the overdose alarm, the value 100 will flash in the information menu to signal that the dosage is insufficient.
- In the time-pause mode: the pump activation time (Ton) and the pump stop time (Pause) are shown in seconds. The two periods Ton and PAU follow one another continuously. In this operating mode during the operating periods (Ton), the engine is partialized at 10% of the nominal flow rate. Ton's time never drops below 5 seconds. Pause time adjusts accordingly.

- The number of hours per day at which the pump is set to calculate the necessary dosage by itself. The actual dosage of the pump for this number of hours per day must be guaranteed by an external system (inhibit and / or flow sensor) which must be regulated for the same number of hours per day, also consisting of several daily shifts, the total of which arrives at the number of hours set on the pump.

5.1.3 SIGNALS OF THE TWO-COLORED LED

The pump is equipped with a two-color LED that can visually provide indications on the operation and status of the pump.

The following combinations may occur:

- **GREEN** light flashing: the pump is dosing.
- **GREEN** steady light: the pump is in dosing mode but is waiting. It could be waiting for the flow, or in time-pause mode, in the moment of pause.
- **RED** flashing light: there is an alarm status.
- **RED** steady light: the pump is off.
- **ORANGE** flashing light: pump priming in progress.
- **ORANGE** steady light: you are browsing the PROGRAMMING menu.

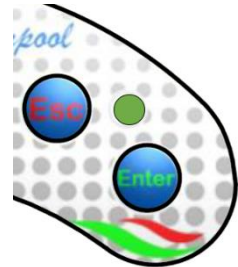

5.2 PROGRAMMING MENU

By pressing the ENTER key from any screen of the INITIAL MENU you enter the PROGRAMMING MENU.

Access to the PROGRAMMING MENU is allowed by entering a 3-digit password. After entering the 3 digits, press ENTER to enter the first item of the PROGRAMMING MENU.

After entering the PROGRAMMING MENU the commands that are found, sequentially, scrolling with the UP / DOWN keys are as follows

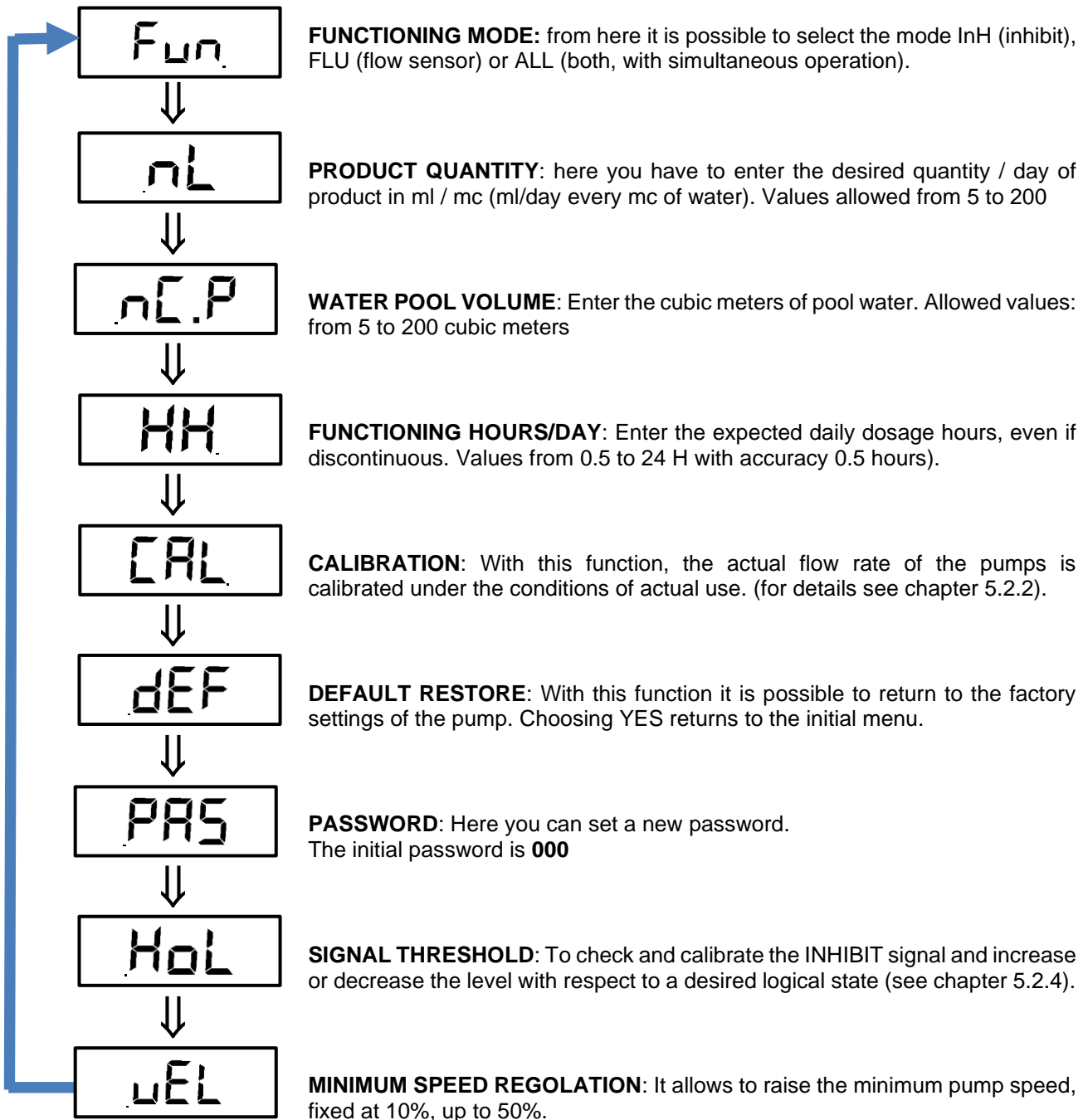
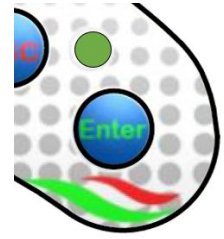

To go back to the initial display screen, from any item of the PROGRAMMING MENU, just press the ESC key for 2 seconds.

From each item of the PROGRAMMING MENU you can access the relevant submenu with the ENTER key and you can return to the upper level with the ESC key.

5.2.1 PROGRAMMING EXAMPLE

The programming of this pump is characterized by being very simple and immediate, as it performs all the necessary calculations by itself to guarantee the necessary dosage.

Let's see how the pump behaves with the following 2 examples which represent the 2 distinct operating modes of the pump: continuous dosing or time-pause dosing.

EXAMPLE 1 - CONTINUOUS DOSING

Starting data:

- Swimming pool with 150 m³ of water
- Daily operating hours for the filtration pump: 6 hours
- Concentration of the product to be dosed: 20 ml / m³ / day (Normally this data is obtained from the instructions label of the product to be dosed)
- Minimum set speed: 10%

Once these 3 parameters have been set, the pump determines by itself the percentage of rpm / engine partialisation, to guarantee a continuous dosage in these 6 hours of operation (even discontinuous).

Assuming that the 3l / h model (code ADS300101000000) is used, the pump automatically positions itself at 17% of the engine speed control, according to this formula:

- Total product to be dosed: 20ml / m³ / day x 150 m³ = 3000 ml / day
- Product to be dosed every hour: 3000 ml / day / 6 hours / day = 500 ml / hour
- Taking into account that the pump is capable of dosing 3 l / h (3000 ml / h) and that for the example in question, 500 ml / h are sufficient, the pump automatically sets itself to 17% (500 ml / h / 3000 ml / h = 0.166 → 17%). Since this value is higher than the set minimum speed (10%), the pump automatically goes into the "continuous" dosing mode.

In this way the pump doses 500 ml / h / 60 min = **8.3 ml / minute**.

EXAMPLE 2 - TIME-PAUSE DOSAGE

Starting data:

- Swimming pool with 50 m³ of water
- Daily operating hours for the filtration pump: 6 hours
- Concentration of the product to be dosed: 20 ml / m³ / day (Normally this data is obtained from the instructions label of the product to be dosed)
- Minimum set speed: 10%

Once these 3 parameters have been set, the pump determines by itself the percentage of rpm / engine partialisation, to guarantee a continuous dosage in these 6 hours of operation (even discontinuous).

Assuming the use of the 3l / h model (code ADS300101000000), the pump automatically positions itself at 10% of the engine speed partialisation (minimum preset value) and additionally goes into time-pause mode, according to this formula:

- Total product to be dosed: 20ml / m³ / day x 50 m³ = 1000 ml / day
- Product to be dosed every hour: 1000 ml / day / 6 hours / day = 166 ml / hour
- Taking into account that the pump is capable of dosing 3 l / h (3000 ml / h) and that for the example in question 166 ml / h are sufficient, the pump should be automatically set to 6% (166 ml / h / 3000 ml / h = 0.055 → 6%).

In this way the pump doses 166 ml / h / 60 min = **2.8 ml / minute**.

The pump, however, is not able to do this dosage continuously, because its minimum continuous dosage is 5 ml / min (3000 ml / h / 60 min = 50 ml / min x 10% of part. = 5 ml / min) and then goes into the time-pause mode which still guarantees the required dosage of 2.8 ml / minute, but instead of doing it in 60 seconds, it does so in 34 seconds (2.8 ml / min / 5 ml / min x 60 sec = 33.6 seconds), while for the remaining 26 seconds it remains paused. At the end of the minute, the cycle restarts, which looks as follows:

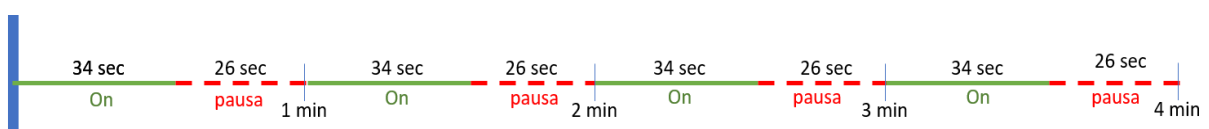

5.2.2 CALIBRATION PUMP

In order for the pump to perform a correct dosage according to the parameters assigned, it is important to perform a calibration of the same, to take into account the actual flow rate in the conditions of use.

For this purpose, use the PROGRAMMING MENU function. CAL

This function allows to calibrate the real pump flow rate, for a correct speed setting.

Do this: Pour the product to be dosed into a graduated container, suitable for reading the ml taken.

After priming the pump, insert the suction bottom filter into the graduated container.

Enter in CAL function. Press L/F/L button and the pump start for 60 second.

At the end of the dosage time, count how much liquid has been withdrawn from the graduated container and enter this value (in ml / minute) on the pump.

The pump will initially display the pump nameplate flow rate data, pre-entered at the factory (1.4 or 3 or 6 lt / h depending on the model chosen). These values are modifiable, according to the result of the calibration test, in a range between 10 and 150 ml / min.

5.2.3 FUNCTIONING HOURS

The pump automatically calculates how much liquid to dose in the set operating hours.

The pump is not equipped with a clock / timer and therefore to decide at what time to activate the dosage relies on the inhibit signal from the swimming pool circulation pump (or other similar signal), or from the signal of a flow sensor, or from the combination of both these signals (logical AND).

When this signal (or combination of signals) is active the dosing pump; when this signal is absent, (or only 1 of the 2 signals is present) the pump stops.

It is the Customer's responsibility to ensure that the number of hours set on the dosing pump corresponds to the number of hours of operation of the swimming pool circulation pump.

If these two values do not coincide these 2 cases can occur:

- The operating hours set on the dosing pump are less than the actual operating hours of the filtration system: The dosing pump performs an overdose compared to what is required, as it also doses in the hours exceeding its setting, receiving an inhibit signal which she tells him to dose.
- The operating hours set on the dosing pump are greater than the actual operating hours of the filtration system: The dosing pump performs an underdosing compared to what is required, as it has calculated the hourly dosage based on a number of hours which, instead, they are not actually made by the filtration system.

5.2.4 INHIBIT SIGNAL THRESHOLD ADJUSTMENT

When the pump regulates its operation according to the INHIBIT or INHIBIT + FLOW signal, the INHIBIT signal must be correct.

The function (High or Low) HoL of the PROGRAMMING MENU allows you to monitor the status of the pump's INHIBIT signal and possibly adjust the threshold if the signal is in a flashing phase (level too low or too high compared to the expected logical state).

Once you enter the function, the following indications will be displayed:

- **"HI" fixed:** enable signal recognized as active. Active inhibit;
- **"Lo" fixed:** enable signal recognized as not active. Inhibit not active;
- **"HI" flashing:** enable signal recognized as active, but slightly above the recognition voltage threshold. If in this state it is necessary that the state is active, it is better to lower the recognition threshold a little to be sure of not having unwanted operations. If not, do the opposite.
- **"Lo" flashing:** enable signal recognized as not active, but slightly below the recognition voltage threshold. If in this state it is necessary that the state is not active, it is better to raise the recognition threshold a little to be sure of not having unwanted operations. If not, do the opposite.

More generally, if the displayed status does not correspond to the actual signal status, or the displayed status is flashing, simply move with the ▲ and ▼ keys to change the threshold, and in particular:

- Signal state not active (Inhibit OFF):
 - if the signal is recognized as active (HI fixed or flashing), or not active but close to the threshold (Lo flashing), press the ▼ key to lower the threshold voltage, until the fixed "Lo" is displayed;

- if the signal is permanently recognized as not active (Lo fixed), it is the correct situation, then proceed to any verification to activate the signal;
- Status of the active signal (Inhibit ON):
 - • If the signal is recognized as not active (Lo fixed or flashing), or active but close to the threshold (HI flashing), press the ▲ key to increase the threshold voltage, until "HI" is displayed fixed;
 - • If the signal is permanently recognized as active (HI fixed), it is the correct situation, then proceed to check whether the signal is disabled;

When the UP or DOWN key is pressed, a bar appears indicating the movement of the threshold up or down. If a central bar is observed near the indication of the signal status, "HI:" or "Lo:" means that the set threshold is the default, that is, it has not changed.

5.2.5 DEFAULT PARAMETERS

Each pump is supplied with some parameters set in the factory.

If you use the function DEF in the PROGRAMMING MENU, you return to the factory settings, which are as follows:

Fun	PROGRAMMING MENU': FUNCTIONING MODE	INHIBIT
nL	PROGRAMMING MENU': PRODUCT QUANTITY	50 ppm/day (ml/mc/day)
nL.P	PROGRAMMING MENU': WATER POOL VOLUME	50 mc
HH	PROGRAMMING MENU': FUNCTIONING HOURS	4.0 hours
PAS	PROGRAMMING MENU': PASSWORD	000
VEL	PROGRAMMING MENU': MINIMUM SPEED	10%

6. MAINTENANCE

This section advises the general rules you need to follow to operate the pump correctly and the steps to carry out periodically to ensure optimal conditions are maintained over time.

6.1 GENERAL RULES

Maintenance operations must be conducted systematically and accurately by following the recommendations reported below. It is difficult to define the standard times required for maintenance beforehand, as there are a number of factors that determine the wear of the pump and in particular the parts that are in contact with the liquid. This also applies to the type of product used to clean the materials that are in contact with it (valves, tubes etc.) as it depends on the compatibility of the material with the chemical product being dosed.

Having said this, we can take as an example a product, such as sodium hypochlorite, that develops crystals, which is often used with our pumps, and with which we have a great deal of experience, and trace an identity kit of the type of maintenance required.

6.2 PERIODIC MAINTENANCE

- Check the foot strainer and clean/replace it periodically from any residuals of crystallised product or dirt deposits.
- Ensure there are no impurities in the suction and delivery tubes, because they may damage the peristaltic tube and, at the same time, cause anomalies in the flow rate;

- **Pump materials in contact with the chemical product such as: foot strainer and injection valve must be checked and cleaned at least every three months.** If the products are particularly aggressive increase the frequency of cleaning;
- Calibrate the pump periodically;

Removing the peristaltic tube

Remove the suction and delivery tubing

Step 1 - Open the front glass cover

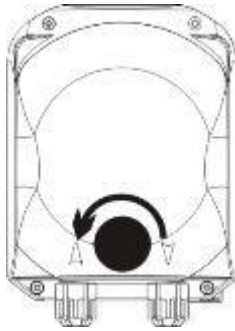

Step 2- Turn the roller clockwise and release the (left) intake ring nut

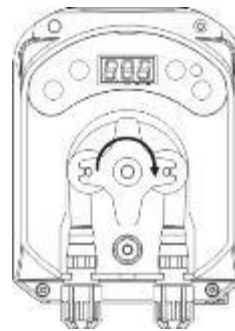

Step 3 - Removing the tube

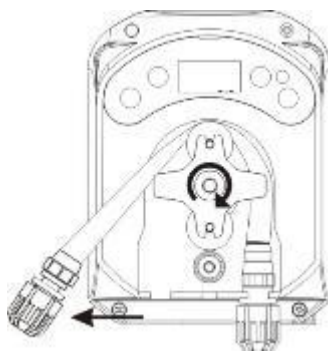

Step 4 - Release t the (right) delivery ring nut and remove it completely



6.3 PLACING BACK PERISTALTIC TUBE

Step 1 - Position the tube and secure it on the left-hand side



Step 2 - Insert it in the bell by turning the roller

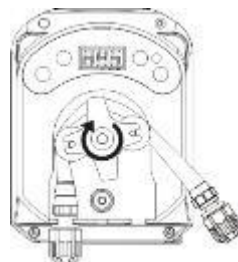

Step 3 - Close the front glass



APPENDICE A – DIMENSIONI / APPENDIX A - DIMENSIONS

