

Instructions for LC Series Oval Gear Flowmeter

Product Instructions

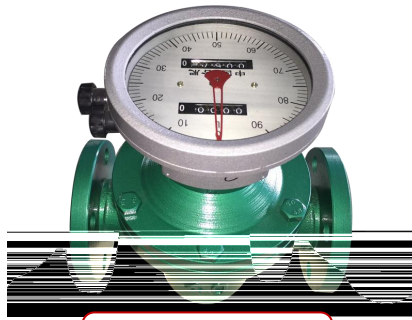

Basic type of pointer



Pointer reset type



Pointer reset type



Basic type of pointer



Clamping high temperature pointer

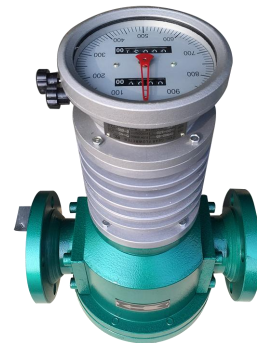

High temperature pointer reset type



Stainless steel pointer reset type



Stainless steel high temperature pointer output type



Stainless steel jacket high temperature output type



LCD Output Type (Output only 4-20mA)



Stainless steel liquid crystal explosion proof type



Liquid crystal explosion proof type

I. Overview

Oval gear flowmeter is a volumetric meter for continuous or intermittent measurement and control of liquid flow in a pipeline. It has many advantages, such as large range, high accuracy, small pressure loss, strong viscosity adaptability, measurement of high temperature and high viscosity liquid, convenient calibration, installation suggestion and so on. It is suitable for flow measurement in petroleum, chemical, chemical fiber, transportation, commerce, food, medicine and health departments.

LC series oval gear flowmeter is equipped with a pointer and printing wheel accumulation device, and can directly display the liquid accumulation flow through the pipeline on the spot. The accumulative, quantitative and instantaneous flow remote transmission control can be realized by attaching the transmitter and the electric display instrument to the counting mechanism. High temperature and high viscosity liquid can be measured by adding radiator or ellipsoid undertooth.

The flowmeter for different liquids (acids, bases, salts, organic solutions, etc.) can be made of different materials.

II. Structure and Working Principles

Oval gear flowmeter consists of flow transmitter and counting mechanism. A high temperature flowmeter is formed if a radiator is installed between the transmitter and the counting mechanism. The transmitter consists of a metering chamber and a sealing coupling with a pair of elliptical gear rotors. The counting mechanism comprises a deceleration mechanism, a regulating mechanism, a counter and a transmitter

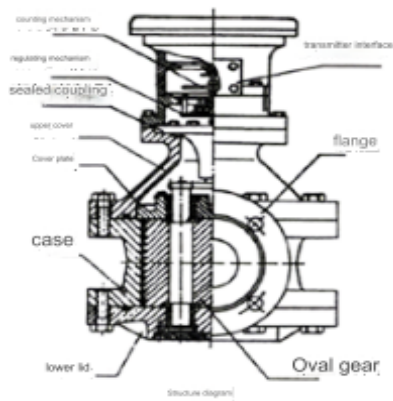

Counting mechanism Number of interfaces of transmitter Regulating mechanism Sealing coupling Top cover
 Flange Cover plate Shell Bottom cover Oval gear
 Structure diagram

The metering chamber has a crescent cavity composed by a pair of oval gear and cover plate as the metering unit of flow. The oval gear is rotated by the pressure difference between the inlet and outlet of the flowmeter so that the liquid is continuously measured by the crescent cavity and sent to the outlet. The liquid that flows every turn is four times of the crescent cavity. By sealing coupling, the total number of turns of oval gear and the speed of rotation are sent to the counting mechanism or transmitter. Thus, we can know the total amount of liquid and instantaneous flow through the pipeline.

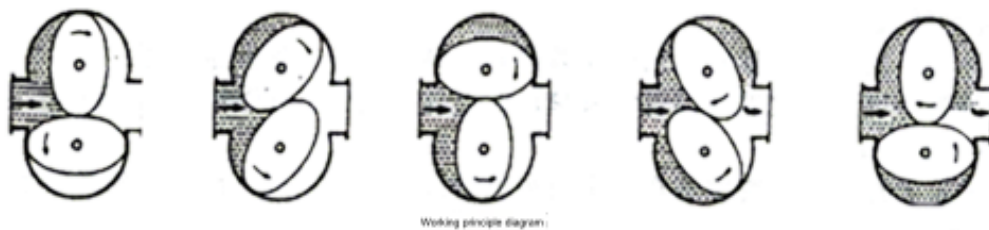

2.1 Functions and codes of various functions

Function	Counter	A1	A	Z	13	J1	ELZ
Pointer Cumulative six rollers		•	•				
Pointer Cumulative six rollers Reset		•	•	•			
Pointer With message		•				•	
Single message (signal output)					•		
LCD display (Instantaneous, cumulative, 4—20mA, pulse, RS485)							•

2.2 Model and material of main parts

Name	Iron casting type	Cast steel type	High-temperature iron casting type	High-temperature cast steel type	High-viscosity iron casting type	High-viscosity cast steel type	Stainless steel	13
Model	LC—A	LC—E	LC—TA	LC—TE	LC—NA	LC—NE	LC—B	LC—13
Body material	Iron casting	Cast steel	Iron casting	Cast steel	Iron casting	Cast steel	Stainless steel	Various materials
Gear material	Iron casting	Iron casting	Iron casting	Iron casting	Iron casting	Iron casting	Stainless steel	Various materials

* For special needs, please specify otherwise

III. Performance (error and pressure loss curve)

Flow - error curve Error % Pressure loss curve % maximum flow Pressure loss curve MPa

Curve of error and pressure loss of flowmeter of 0.5 level

1. aviation gasoline 0.7mPa.s
2. water 1 mPa.s
3. light diesel oil 5mPa.s
4. transformer oil 20mPa.s

Explanations: 1. The flowmeter error is adjusted up and down to 0 axis by various liquid precision adjusting devices in the diagram to make the error best.

2. The precision of the flowmeter can be improved by using the precision adjusting device under the

condition of reducing the flow range ratio of any liquid.

IV. Te

200	48-238 m ³ /h	34-170 m ³ /h
-----	--------------------------	--------------------------

4.3 High-precision oval gear flowmeter (precision: 0.2%)

TR \ M	LC—A Iron casting type	LC—B Stainless steel type	LC—E Cast steel type
Nominal pressure MPa	1.6	1.6、2.5、4.0、6.3	1.6、2.5、4.0、6.3
Temperature range °C	Conventional pointer type: -20~+80; High-temperature pointer type: -20~+200; Conventional LCD type: -20~+60; High-temperature LCD type: -20~+150;		
Precision level	0.2%		
Flow range m ³ /h			
Caliber (mm)	0.6—2 mPa.s	2—200 mPa.s	
10		0.2—0.4 m ³ /h	
15		0.5—1.5 m ³ /h	
20	1.5—3 m ³ /h	1—3 m ³ /h	
25	3—6 m ³ /h	1.2—6 m ³ /h	
40	8—15 m ³ /h	5—15 m ³ /h	
50	12—24 m ³ /h	8—24 m ³ /h	
65	20—40 m ³ /h	10—40 m ³ /h	
80 (light type)	20—40 m ³ /h	10—40 m ³ /h	
80 (heavy type)	30—60 m ³ /h	15—60 m ³ /h	
100	40—100 m ³ /h	20—100 m ³ /h	
150	90—190 m ³ /h	56—190 m ³ /h	
200	170—340 m ³ /h	68—340 m ³ /h	

4.4 High-precision and high-viscosity oval gear flowmeter (precision: 0.2%)

TR \ M	LC—NA High-viscosity iron casting type	LC—NE High-viscosity cast steel type	LC—NB High-viscosity stainless steel type
Nominal pressure MPa	1.6	1.6, 2.5, 4.0, 6.3	1.6, 2.5, 4.0, 6.3
Temperature range °C	Conventional pointer type: -20~+80; High-temperature pointer type: -20~+200; Conventional LCD type: -20~+60; High-temperature LCD type: -20~+150;		
Precision grade	0.2%		
Flow range m ³ /h			
Caliber (mm)	Viscosity: 200—1000mPa.s	Viscosity: 1000-2000mPa.s	
10	0.08—0.3 m ³ /h	0.06-0.2 m ³ /h	
15	0.3—1.0 m ³ /h	0.2-0.7 m ³ /h	
20	0.6—2.1 m ³ /h	0.5-1.5 m ³ /h	
25	1-4.2 m ³ /h	0.8-3 m ³ /h	
40	3—10.5 m ³ /h	2-7.5 m ³ /h	
50	4-16.8 m ³ /h	3-12 m ³ /h	
65	8-28 m ³ /h	6-20 m ³ /h	
80 (light type)	8-28 m ³ /h	6-20 m ³ /h	
80 (heavy type)	10-42 m ³ /h	8-30 m ³ /h	
100	15-70 m ³ /h	12-50 m ³ /h	
150	34-133 m ³ /h	30-95 m ³ /h	

200	56-238 m ³ /h	50-170 m ³ /h
-----	--------------------------	--------------------------

V. LC-13 Oval Gear Flowmeter

LC-13 oval gear flow transmitter consists of the body and transmitter, by which liquid flow in the pipeline can be converted into flow pulse signal or analog signal output. It can be matched with the display instrument or other secondary instruments and systems of our factory. It is used for remote metering display, automatic control and regulation and recording.

5.1 Technical performances

- 1) Suitable for all cast iron, cast steel, stainless steel flow transmitters.
- 2) Transmitter: MF(4-20mA), GF(photoelectric pulse)
- 3) Allowable working voltage: DC12V, DC24V
- 4) Pipeline connection flange: JB/T79~82—1994
- 5) Transmission distance: 0-1000M
- 6) Electrical performance accuracy: ±1 pulse
- 7) Ambient temperature: -10~+60°C



Graph of LC—13 flowmeter

Specification and dispatch parameters

Caliber	Viscosity	Output signal			
	Flow range (m ³ /h)	Conventional		Customized	
	2~200mpa.s	Coefficient (L/P)	Frequency (P/S)	Coefficient (L/P)	Frequency (P/S)
10	0.08~0.4	0.00171	81.22	0.000285	487.32
15	0.3~1.5	0.00598	69.62	0.000996	417.72
20	0.6~3	0.01217	68.44	0.00202	410.64
25	0.8~6	0.01193	140	0.00198	840
40	3-15	0.03084	135	0.00514	810
Note	Additional caliber parameters are to be determined				

VI. Transmitter

GF-IGF-II transmitter is a high precision pulse sensor, which is matched with LC SERIES OVAL GEAR FLOWMETER. The flow rate of the measured medium can be converted into an electrical pulse signal for remote transmission.

Transmitter Counter Transmitting block Wiring
 Transmitting plate

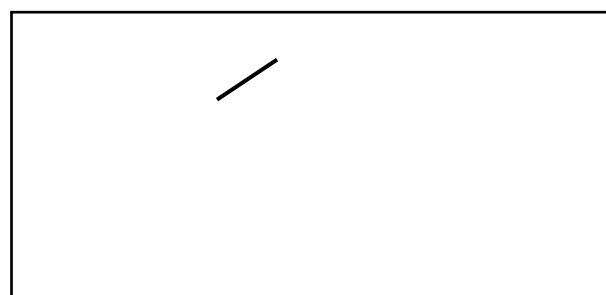

6.1 Technical parameters

1. Working voltage: DC12/24V
2. Transmission distance:0-1000M
3. Electrical performance accuracy: ±1 pulse
4. Ambient temperature:-10~+65°C
5. Explosion-proof grade: ExdIIBT4

6.2 Wiring diagram of GF transmitter

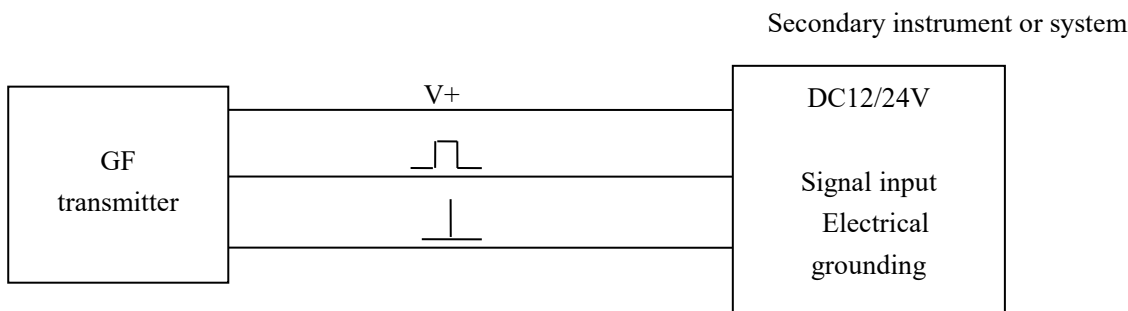

6.3 Matching pulse equivalent between transmitter and LC Series Oval Gear Flowmeter

DN	A1/J1 counter	
	L/P	P/S
10	0.004	27.77
15	0.04	10.41
20	0.04	20.83
25	0.04	41.67
40	0.4	10.41
50	0.4	16.67
65/80 (light type)	0.4	27.77
80 (heavy type)	0.4	41.67
100	0.4	69.44
150	0.4	52.78
200	0.4	94.44

VII. MF series 4-20mA

MF flow transmitter is a converter that collects the flow signal of the Flowmeter and converts it into 4-20 ma and outputs to the system terminal.

LB07 has 5 parameters, namely P00-P04 as follows:

P00: Coefficient of Flowmeter (pulse equivalent), Unit 0.00001-9.99999 L/Pulse

P01: Maximum flow of the flowmeter (range) Unit: m3/h, two decimal places

P02: Minimum flow of the flowmeter (To calculate the reset time Unit: m3/h, two decimal places

P03: 4-20mA is adjusted to 0. The greater the value, the greater the current, and vice versa

P04: 4-20mA is adjusted to full. The greater the value, the greater the current, and vice versa

Commissioning methods LB07 has two keys: left key (M) and right key (S). When the meter is connected, the screen will display LB07 and then display F 0.00, and enter into the running state. If short pressing key M in the running state, the screen will switch to display the accumulation (unit: L). if short pressing key M again, the screen will display the current. The users can check it with the testing equipment. And then press the m key to display the above three values in turn.

When displaying the accumulation, press S key and the accumulation is reset. This function is used to adjust for pulse loss.

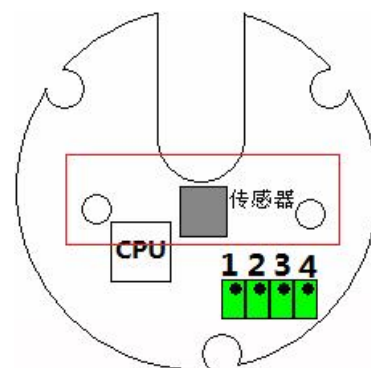

Parameter modification

In the running state, long press key S and the screen will display P00 and P00 value, and then short press key S, and it will display P01, P02 in turn.

To modify certain variable, short press key M after displaying the variable. The first place to change the value will flash. It can be increased with key S, moved and increased. After the variable has been set, short press key M until all places do not flash. Short press key S to display the next variable. When all changes are made, hold down key S until the screen displays SaUEd flashes back to running state. The parameter is saved at this time.

Wiring description: 1: V+; 2: SO; 3: I+; 4: GND

Function	Terminal name	Wiring mode
Two-wire 4-20mA output	V+	24V positive power supply
	GND	Two-wire 4-20mA positive end
Three-wire 4-20mA output	V+	24V positive power supply
	I+	4-20mA Current output positive
	GND	4-20mA Current output negative, 24V Negative power supply

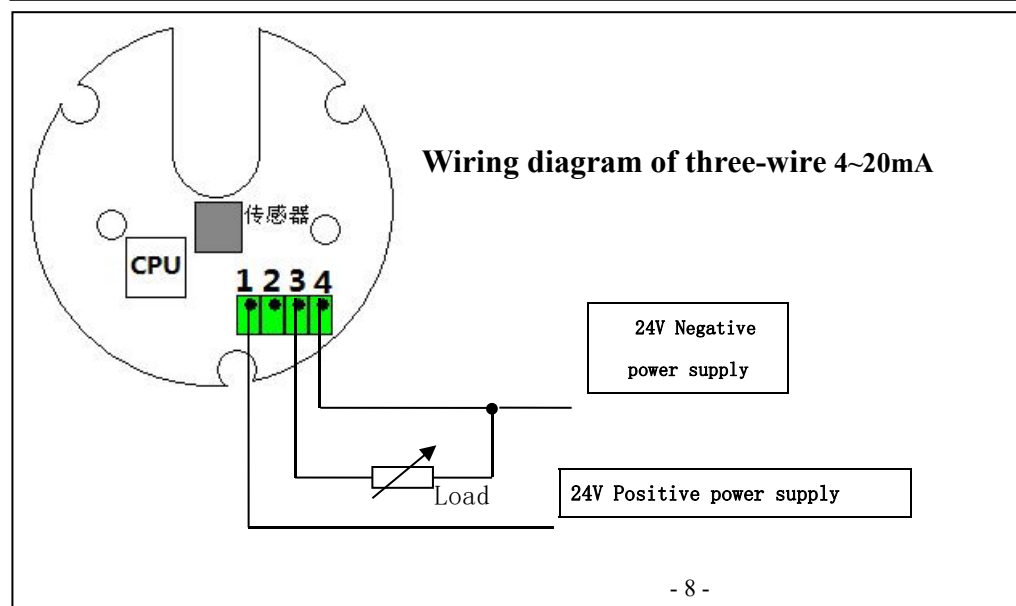
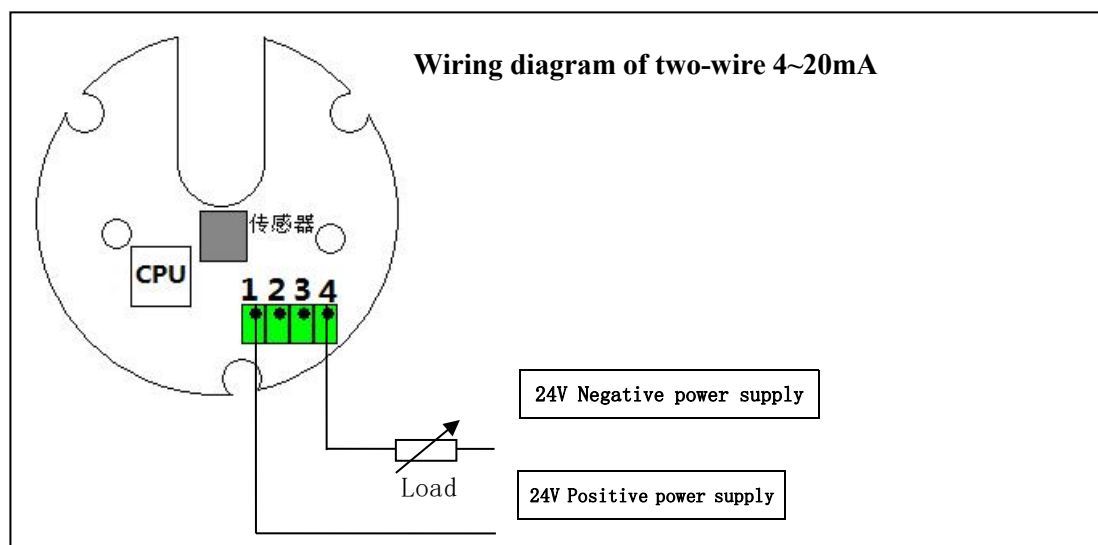

III. Physical Dimensions

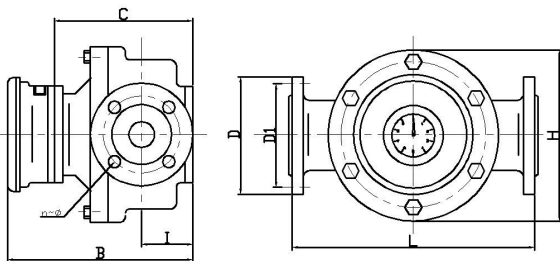

DN10~DN50 (light type)

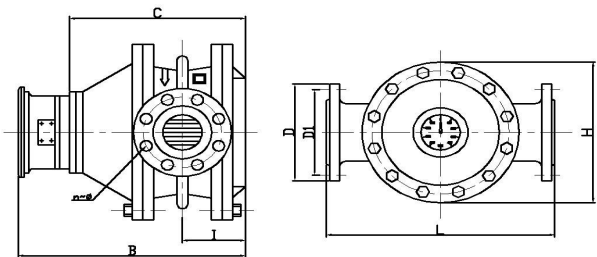

DN50 (heavy type)~DN100

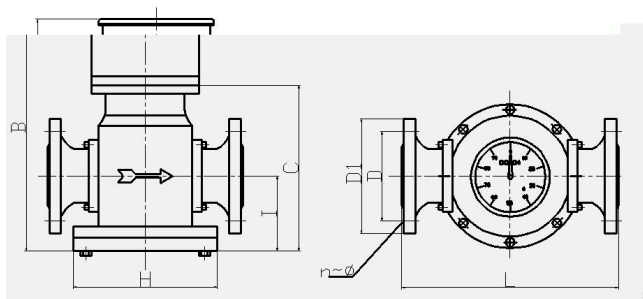

DN65/DN80 (light type)

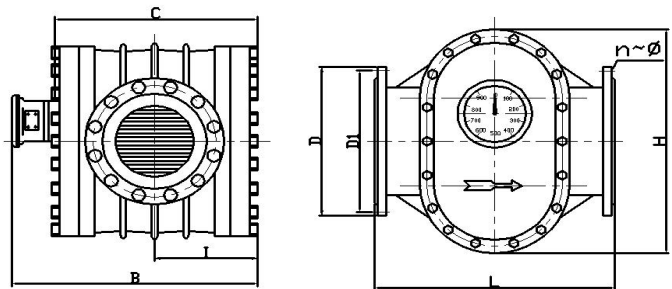

DN150~DN200

8.1 Physical dimensions of oval gear flowmeter of iron casting type

Model: LC—A, LC—NA (High temperature type: DN50 light and below B plus 100mm, DN50 heavy and above B plus 160mm)

DN(mm)	L(mm)	H(mm)	B(mm)	C(mm)	I(mm)	D(mm)	D ₁ (mm)	N	Φ(mm)
10	150	100	210	120	45	90	60	4	14
15	170	118	226	136	48	95	65	4	14
20	200	150	238	148	53	105	75	4	14
25	260	180	246	156	60	115	85	4	14
40	245	180	271	181	77	145	110	4	18
50 (light type)	290	218	310	220	80	160	125	4	18
50 (heavy type)	340	250	372	230	88	160	125	4	18
65	325	245	320	220	90	180	145	4	18
80 (light type)	325	245	320	220	90	195	160	8	18
80 (heavy type)	420	325	433	253	118	195	160	8	18
100	515	418	458	278	131	215	180	8	18
150	540	515	557	377	210	280	240	8	23
200	650	650	624	444	247	335	295	12	23

Oval Gear

Physical dimensions of type

—E, I (High temperature type: DN50 and below B plus 100mm, DN50 heavy and above B plus 160mm)

DN(mm)	L(mm)	H(mm)	B(mm)	C(mm)	I(mm)	D(mm)	D ₁ (mm)	N	Φ(mm)
10	150	100	212	120	45	90	60	4	14
15	200	138	232	142	53	95	65	4	14
20	250	164	250	150	63	105	75	4	14
25	300	202	252	162	68	115	85	4	14
40	300	202	293	203	83	150	110	4	18
50 (light type)	320	220	325	235	85	160	125	4	18
50 (heavy type)	384	262	394	394	88	160	125	4	18
65	350	260	365	275	100	180	145	4	18
80 (light type)	350	260	365	275	100	200	160	8	18
80 (heavy type)	450	337	452	272	118	200	160	8	18
100	555	442	478	298	131	220	180	8	18
150	540	510	557	377	210	285	240	8	23
200	650	650	624	436	247	340	295	12	23

* Flange dimensions is 1.6 MPA standard; (length and Flange dimensions can be customized)

16 8.3 Physical dimensions of LC—B stainless steel oval gear flowmeter (unit: mm) (High temperature type: DN50 light and below B plus 100mm, DN50 heavy and above B plus 160mm)

DN(mm) L(mm) H(mm) B(mm) C(mm) I(mm)

dimensions correspond to the above table.

IX. Installation and Use of Oval Gear Flowmeter

- 9.1 A matching filter shall be installed before the flowmeter, and the outlet of the matching filter is connected to the inlet of the flowmeter. The arrow points on both bodies are consistent with the flow direction of the liquid.
- 9.2 When the liquid under test contains gas, the gas elimination filter should be installed before the Flowmeter.
- 9.3 No matter whether the pipeline is installed vertically or horizontally, the oval gear in the flowmeter shall be installed in a horizontal position (i.e. the gauge disc shall be perpendicular to the ground).
- 9.4 When the flowmeter is properly installed, if it is not easy to read, turn the counter to 180 degrees or 90 degrees.
- 9.5 The new flowmeter pushes the elliptical gear several times from the exit with a bamboo stick before installation. If it doesn't move, soak in diesel oil (Avoid sediment after factory check).
- 9.6 Flow control valve should be installed at the inlet of the Flowmeter, and open and close valve is installed at the outlet. When using open and close valve, start slowly, do not suddenly open to prevent "water hammer" phenomenon.
- 9.7 Before installing the flowmeter on the new pipeline, the pipeline needs to be flushed, and the straight pipe section (instead of the position of the Flowmeter) is used to prevent welding slag, sundries and so on from entering the flowmeter.
- 9.8 It is strictly forbidden to check the flowmeter of cast iron and steel with water.
- 9.9 The flow size of the flowmeter in use shall not exceed the technical requirements. The flowmeter operates at a maximum flow rate of 50-80%.
- 9.0 If the tested liquid is chemically corrosive, a flowmeter of stainless steel should be selected.

X. Error Calculation and Adjustment

10.1 The basic errors of flowmeter and the measured value of each flow point are calculated respectively: (volumetric method)

$$E=(V_m-V)/V \times 100\%$$

E—Flowmeter error (Generally cumulative error) takes two-digit effective numbers.

V_m —Measured value of Flowmeter

V—Measured value of flow standard device after correction (Actual value)

From the calculation formula of basic errors, when

$V_m > V$, the basic error of the flowmeter is "+", indicating the flowmeter goes fast;

$V_m < V$, the basic error of the flowmeter is "-", indicating the flowmeter goes slow.

In order to make the Flowmeter error within the basic error limit, error adjustment is often needed, that is to change the mechanical transmission speed ratio by replacing a pair of adjusting gears (adjusting teeth) installed in the counter, so that the indicator value of the Flowmeter can be adjusted.

The error adjustment cannot change the flow characteristics of the flow meter, only make its characteristic curve artificially in the new coordinate system.

In general, the basic error range of its maximum and minimum flow points is not the basic error limit of the specified precision in the specified (or actual use) flow range, and the basic error range of its Flowmeter can be qualified by error adjustment.

For used flow meters, the original adjustment gear set is used to check the error and then the error adjustment is made according to the specific error situation.

10.2 Error adjustment method of oval gear flowmeter (Description of Use of Error Adjustment Sheet)

1. The standard double-layer gear is 38/35 when designed. If the flowmeter goes fast during the test, such as +1.02~0.3, the corresponding “zero” place of 38/35 gear should be moved to the position of +0.63 of 41/38 gear. In this way, the error curve is located in the new coordinate system and the error of the flowmeter is adjusted into the range of +0.33~—0.33.

The error of flowmeter may change and exceed the difference due to different working conditions and changes. It may be adjusted as long as the error range does not exceed 1%. For example when the instrument error reduces to -0.7~+0.2 and the double-layer gear should be replaced, we should firstly check the number of gears. If it is 38/35, it is adjusted with method (1); if it is 41/38, the corresponding error of gear +0.63 should be 0. At this time, 41/38 gear should be replaced to 40/37 double-layer gear and the error may be adjusted to the range of -0.5~+0.4

XI. Common Faults, Causes and Troubleshooting Methods

Fault phenomenon	Causes	Measures	Notes
Oval gear does not rotate	1. There are sundries in the pipeline 2. The liquid tested contains more debris; the filter is damaged; the sundries enter the meter and the gear is blocked.	Remove the instrument and pipeline and repair the filter	
Leakage of axial sealing coupling	Sealing filler wears or lacks seal oil	Tighten gland or replace packing, fill sealing oil	
Unstable pointer rotation	Pointer and washer are loose or rotating parts are dumb	Retighten to eliminate inflexibility	
Small flow error is too negative	Elliptical gear collides with the wall of the measuring box due to wear of the bearing or deformation of the measuring cavity	Replace the bearings, repair the metering cavity and gear at the deformed place, make the rotation flexible and ensure the required clearance	Calibrate after repair
Error changes a lot	Large or gaseous flow pulsation	Reduce pulsation and add gas separator	
Error is too large but not more than ±1%.	Changes in service life or clearance after maintenance	Re-calibrate and adjust it	For level 0.2 flowmeter, the maximum and minimum change does not exceed ±0.17%
No signal when transmitting	1. The position of transmitting block is improper 2. The polarity is reverse	Re-adjust position, move left and right Re-wire it (+ is connected to red wire, - is connected to black wire)	

XII. Others

1. The instrument is tested with diesel before leaving the factory referring to national metrological verification regulations JJG667 2010 Liquid Volumetric Flowmeter. Please do not calibrate with water.
2. The matched filter is an independent product and priced additionally (it may be matched by the factory).

XIII. Ordering Instructions

1. Names, models, specifications, materials.
2. Medium temperature, working pressure, flow range.
3. Medium viscosity or name.
4. Special requirements, such as remote signal transmission, explosion proofing.
5. Name of ordering and receiving units.
6. Detailed communication address, telephone number, fax number, postal code.
7. Settlement unit, account opening bank, account number.
8. Arrival station name, contact person.
9. For more information of the products, please call us.
10. The products of our factory implement three-guarantee and implement tracking maintenance in the service period.

XIV. Models and Identifications

Type code	—	Special mark	Material mark	Diameter	Pressure	/	Counter	Transmitter	Description
LC	—								Oval gear flowmeter
		T							High temperature type
		U							Jacket type
		N							High viscosity type
			A						Iron casting type
			E						Cast steel type
			B						304 Stainless steel type
			C						316 Stainless steel type
				10 40 200					Nominal diameter: DN=10mm ° ° ° Nominal diameter: DN=40mm ° ° ° Nominal diameter: DN=200mm
					.1				Nominal pressure (1.0Mpa)
					.2				Nominal pressure (1.6Mpa)
					.3				Nominal pressure (2.5MPa)
					.4				Nominal pressure (4.0MPa)
					.6				Nominal pressure (6.3MPa)
							A/A1		DN50 (light type) with mechanical pointer display; A1 may be equipped with transmitter
							J1		DN50 (heavy) with mechanical pointer display; It may be equipped with transmitter;
							A5/A6		A5 Single pointer wheel display, A6 point reset may be equipped with transmitter
							Z		Double-handle reset
							13		Output signal only (pulse, 4-20mA)
							ELZ (BELZ)		LCD (-1 output pulse; -2 output 4-20mA;-3 output RS485)
							GF-I		3-wire pulse (clockwise)
							GF-II		3-wire pulse (anticlockwise)
							MF		4—20mA analogue (-1 two-wire system; -2 three-wire system)

Note: suffix of level 0.2 product - J

The wiring diagram

PLUSE OUT Wiring diagram

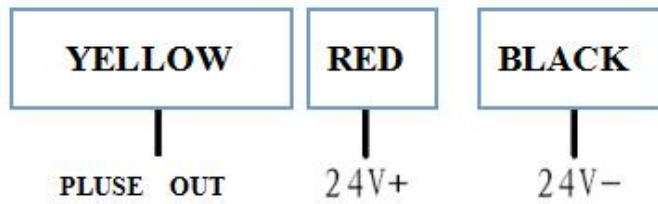

4-20mA OUT Wiring diagram

