

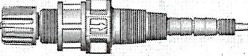





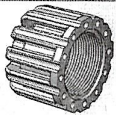

VALVOLA INIEZIONE 3/8" - 1/2"
3/8" - 1/2" INJECTION VALVE

Componenti / Kit contents		
FIG. / REF.	DESCRIZIONE / DESCRIPTION	Q.TA' / Q.TY
	VALVOLA DI INIEZIONE INJECTION VALVE	1
	BOCCOLA PER TUBI 6x8 TUBE BUSH 6x8	1
	UGELLO PER TUBI 6x8 TUBE NOZZLE 6x8	1
	GHIERA 1/2" NIPPLE 1/2"	1
	BOCCOLA PER TUBI 10x14 TUBE BUSH 10x14	1
	UGELLO PER TUBI 10x14 TUBE NOZZLE 10x14	1
	O-RING PER UGELLO 10x14 NOZZLE O-RING 10x14	1
	DISTANZIALE PER MOLLA SPACER SPRING	1
	GHIERA M10x1 M10x1 TUBE NUT	1
	TUBO FLESSIBILE 4X6 FLEXIBLE HOSE 4X6	NON FORNITO NOT SUPPLIED

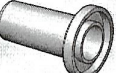
VALVOLA INIEZIONE 3/8" - 1/2"
3/8" - 1/2" INJECTION VALVE

Configurazioni / Configurations

SCELTA LIVELLO DI CONTROPRESSIONE / COUNTERPRESSURE LEVEL OPTION

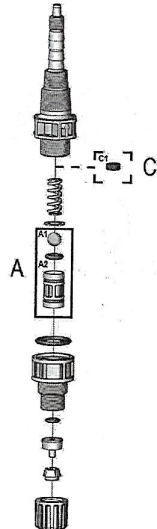

Vista esplosa / Exploded view

CONFIGURAZIONE / CONFIGURATION A (STANDARD):

- Sfera D9,5 / D9,5 ball
- Contropressione / counterpressure: **0,4 bar**

CONFIGURAZIONE / CONFIGURATION A + C:

- Sfera D9,5 + distanziale / D9,5 ball + spacer
- Contropressione / counterpressure: **1,0 bar**

SCELTA LUNGHEZZA INIETTORE CON FORO DI USCITA DIAMETRO 7 mm
7 mm OUTPUT HOLE DIAMETER INJECTOR LENGHT OPTION

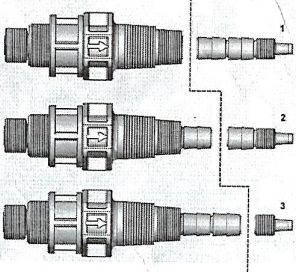

Iniettore con lunghezze prestabilite / preset lengths injector

CORTO / SHORT
Lunghezza minima
Minimal length

MEDIO
MEDIUM

LUNGO
LONG

Da tagliare in base alle necessità
Cut according to requirements

VALVOLA INIEZIONE 3/8" – 1/2"
3/8" – 1/2" INJECTION VALVE

SCELTA ATTACCO TUBI 10 X14
CONNECTION FOR 10x14 HOSE OPTION

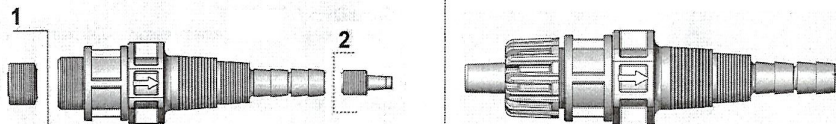

Taglio attacco 3/8" (1) e taglio beccuccio D3 (2)
3/8" connection cutting (1) and D3 nozzle cutting (2)

Completivo valvola per tubi 10x14
Valve overall view for tube 10x14

KIT FISSAGGIO TUBI 6x8 E 10x14
FIXATION KIT FOR TUBE 6x8 AND 10x14

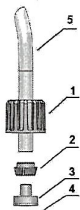

Kit fissaggio tubi 6 x 8

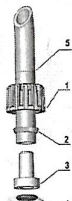

Kit fissaggio tubi 10 x 14

1. Ghiera / Nut
2. Boccola / Bush
3. Ugello / Nozzle
4. O-ring
5. Tubo / Hose

ESEMPI DI INSTALLAZIONE
INSTALLATION EXAMPLES

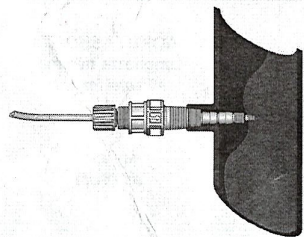

INSTALLAZIONE SU ATTACCO 3/8"
INSTALLATION SU ATTACCO 3/8"

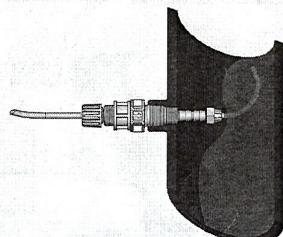

INSTALLAZIONE SU ATTACCO 1/2" CON PROLUNGA
FLESSIBILE 4x6 ANTI INCROSTAZIONI /
INSTALLATION ON 1/2" CONNECTION WITH ANTIFOAM
4x6 FLEXIBLE EXTENSION

VALVOLA INIEZIONE 3/8" – 1/2"
3/8" – 1/2" INJECTION VALVE

APPLICABILE A / APPLICABLE TO :

MODELLO / MODEL		O-RING		CORPO / BODY	
SVA00300	VALVOLA DI INIEZIONE 3/8" – 1/2" 3/8 – 1/2" INJECTION VALVE	0	FPM	1	PVDF
		1	EPDM	2	PP

COMPLESSIVO / COMPREHENSIVE VIEW AND FEATURES

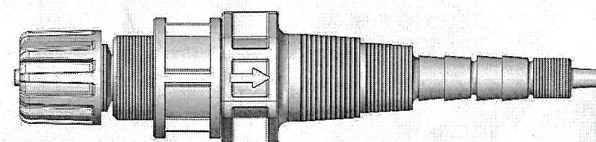

CONFIGURAZIONE STANDARD / STANDARD CONFIGURATION

DIMENSIONI E CARATTERISTICHE / OVERALL DIMENSIONS AND CHARACTERISTICS

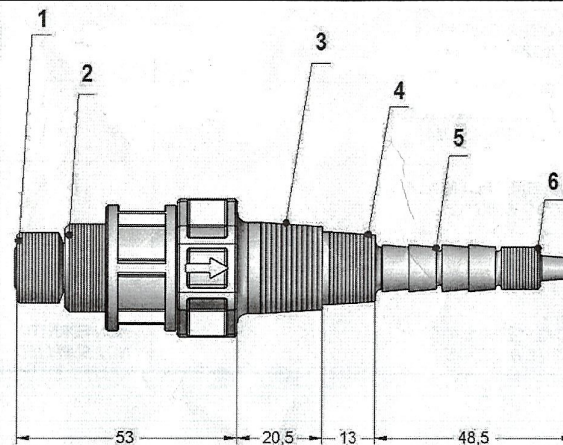

- 1 attacco pompa 3/8"
3/8" pump connection
- 2 attacco pompa 1/2"
1/2" pump connection
- 3 attacco su impianto 1/2"gc
1/2" pipeline connection
- 4 attacco su impianto 3/8"gc
3/8" pipeline connection
- 5 prolunga ad intagli
pre-cut extension
- 6 attacco M10x1
M10x1 threaded connection